

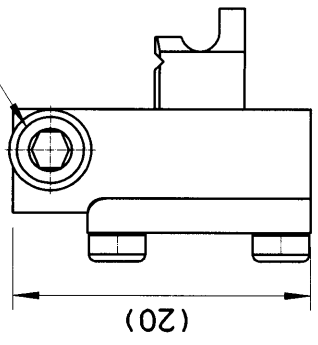

THE INFORMATION CONTAIN HEREIN IS PROPRIETARY TO HIROSE ELECTRIC (USA), INC., ALL RIGHTS THEREIN ARE RESERVED AND SHALL NOT BE USED, DUPLICATED, OR FURTHER DISSEMINATED FOR ANY PURPOSE WITHOUT THE CONSENT OF HIROSE ELECTRIC (USA), INC.

M3 SOCKET HEAD CAP SCREW, 12 mm LONG, SHOWN FOR REFERENCE ONLY, NOT INSTALLED



M3 FLAT HEAD PHILLIPS MACHINE SCREW, 6 mm LONG, SHOWN FOR REFERENCE ONLY, NOT INSTALLED

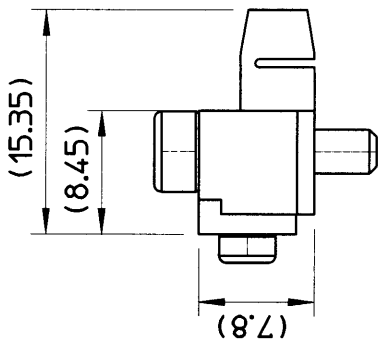
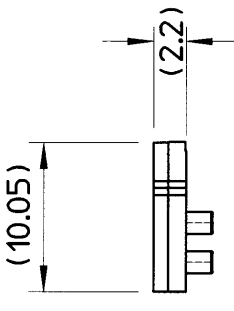
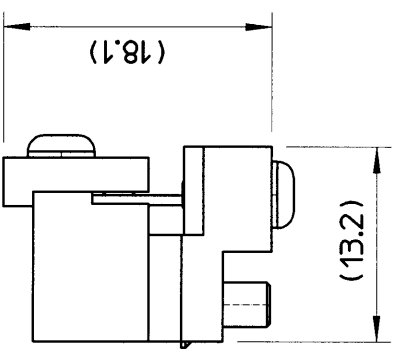
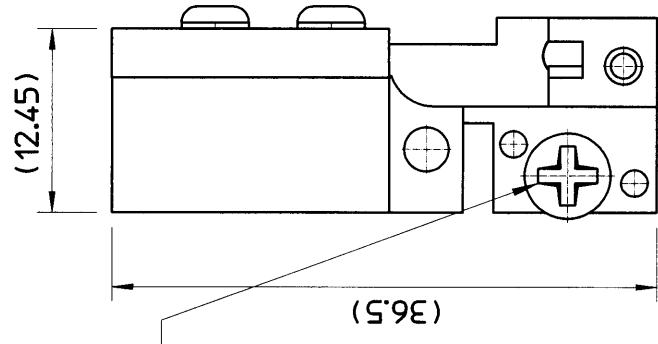
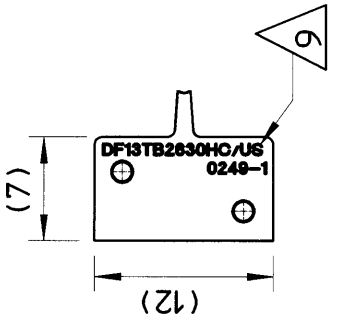

CUT PUNCH ASSY

ANVIL ASSY

CONTACT FEEDER ASSY

M2.5 SOCKET HEAD CAP SCREW, 10 mm LONG, SHOWN FOR REFERENCE ONLY, NOT INSTALLED

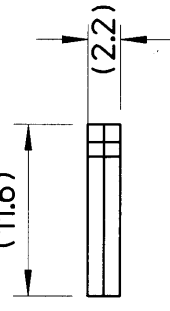
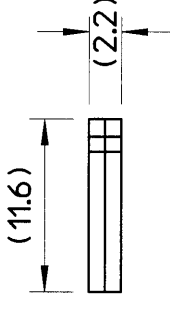
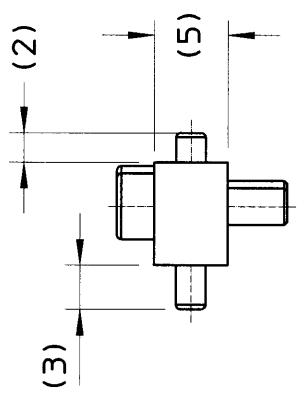
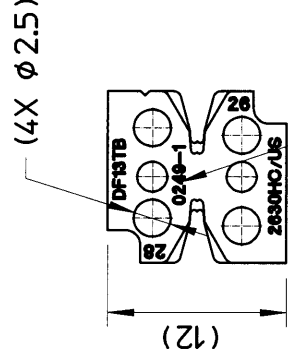
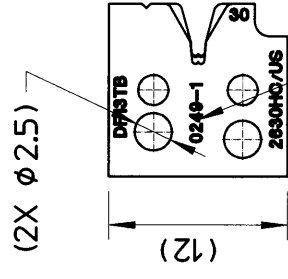
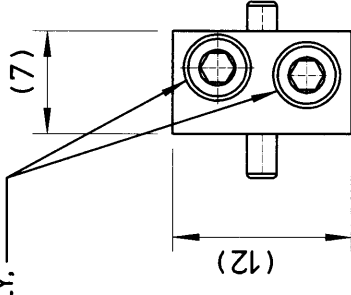

CRIMPER ASSY

PUNCH STOPPER ASSY

DATE CODE EXPLANATION:

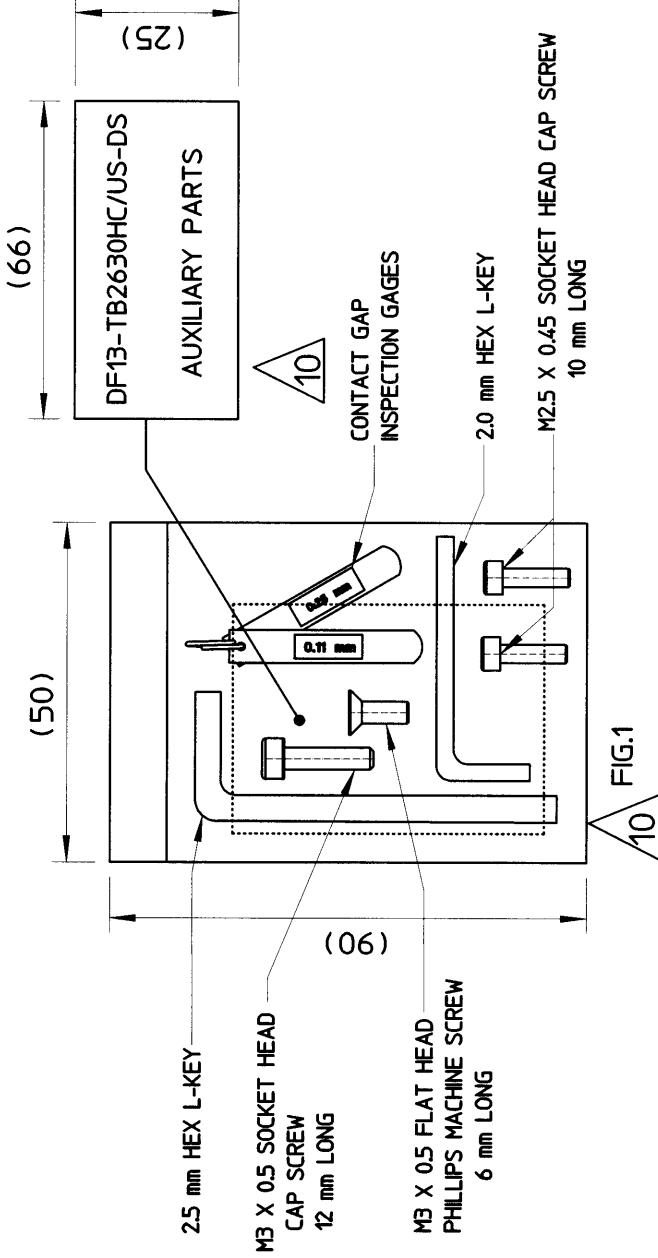
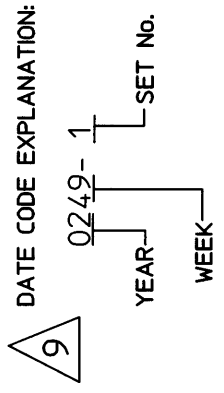

FIG.1

REVISIONS				
ZONE	REV.	DESCRIPTION	DATE	APPROVED
	A	REVISED PER DCN# 0896		
	B	REVISED PER DCN# 0913	11/26/03	A.S.
	C	REVISED PER DCN# 0923	2/2/04	M.N.

FORM NO. <b>0AG18</b>	UNLESS OTHERWISE SPECIFIED DIMENSIONS ARE IN MILLIMETERS TOLERANCES ARE: X = ±0.1 .XX = ±0.05 .XXX = ±0.03 ANGLE = ±1°	APPROVALS	DATE
		Drawn Luis Lostana	05/05/03
PROJECT NO.	CL NUMBER	SCALE	SHEET
XXXXXXXXXX	5920-8502-5	N/A	2 OF 2
TEST ASBY.	SIZE	DWG NUMBER	REV.
USED ON	B	DF13-TB2630HC/US-DS	C
APPLICATION			

CUSTOMER USE DRAWING

**HRS**  
HIROSE ELECTRIC (U.S.A), INC  
SIMI VALLEY, CALIFORNIA 93065

PART NUMBER  
**DF13-TB2630HC/US-DS**

CL NUMBER  
**5920-8502-5**

SCALE  
N/A

SHEET  
2 OF 2